



LAYERZERO
POWER SYSTEMS, INC.

The Foundation Layer

Series 70 ePanel-2

Wall-Mounted Remote Power Panel



Product Brochure

ePanel: Save Space, Increase Safety, And Maximize Reliability

ePanel Uses A Wall-Mounted Design To Maximize The Effectiveness Of Critical Floor Space

Web-enabled Series 70: ePanel-2 Wall-Mounted Distribution Panels save space. ePanel is highly configurable to meet a variety of business goals, and can be installed at the end of server rows or on the walls. The ePanel utilizes the IP-20 finger-safe SafePanel™, requires Category-0 PPE, provides selective trip coordination to 35 kAIC, enables Bluetooth connectivity, contains waveform capture on every breaker, with Modbus/TCP, SNMP, HTTP web browsing protocols supported.



LayerZero's ePanel-2 Product Features

Reliability

- ✓ **Silver Plated Input Terminals:** Silver Has Excellent Conductivity To Provide Superior Electrical Performance and Reliability
- ✓ **Machined Hardware:** Machined Cap Screws and Engineered Disc Springs Maintain Constant Torque Throughout Product Life
- ✓ **Convection Cooling:** Natural Convection-Cooled Heat Dissipation System is Maintenance-Free
- ✓ **Serialized Critical Board Tracking:** Critical Boards Are Serialized And Cataloged in an Active Database For Traceability
- ✓ **Selective Trip Coordination:** Main Breaker Will Not Trip In The Event of a Downstream Fault.

Safety

- ✓ **InSight™ IR Portholes:** Bolted Connections Can Be IR Scanned With the Dead-Front Doors Closed
- ✓ **Sectionalized Components:** Separations Between Each Section To Maintain Maximum Operator Safety
- ✓ **Polycarbonate Windows:** Allows Circuit Breaker Positions Viewed With The Dead-Front Door Closed
- ✓ **Dead Front Hinged Doors:** Barrier To Provide A Safe Working Area With No Exposed Live Parts
- ✓ **Guided Wireways:** Helps Keep Wires Organized

Connectivity

- ✓ **Ethernet Connectivity:** Secure VPN Router Connects To Network For Advanced Remote Monitoring Capabilities
- ✓ **Modbus/TCP:** Open Connectivity to Existing Monitoring Systems Without Proprietary Limitations
- ✓ **NTP Time Clock Synchronization:** Facilitates Timeline-Based Logging For Post-Event Reconstruction
- ✓ **SNMP Connectivity:** Permits Remote Management Via Simple Network Management Protocol
- ✓ **Bluetooth Connectivity:** Wirelessly Set Up Panels At The Point-Of-Impact

zenDPQM

- ✓ **Real-Time Waveform Capture:** Automatically Captures A Picture Of The Power Six-Cycles Before and After Every Event
- ✓ **Optional Local Touch-Screen Interface:** Password-Protected Color Touch-Screen GUI For Local ePODs Setup/Operation
- ✓ **Black-Box Forensics:** ePanel-2 Captures and Records Events To Provide Vital Information In Root-Cause Analysis

Equipment Layout

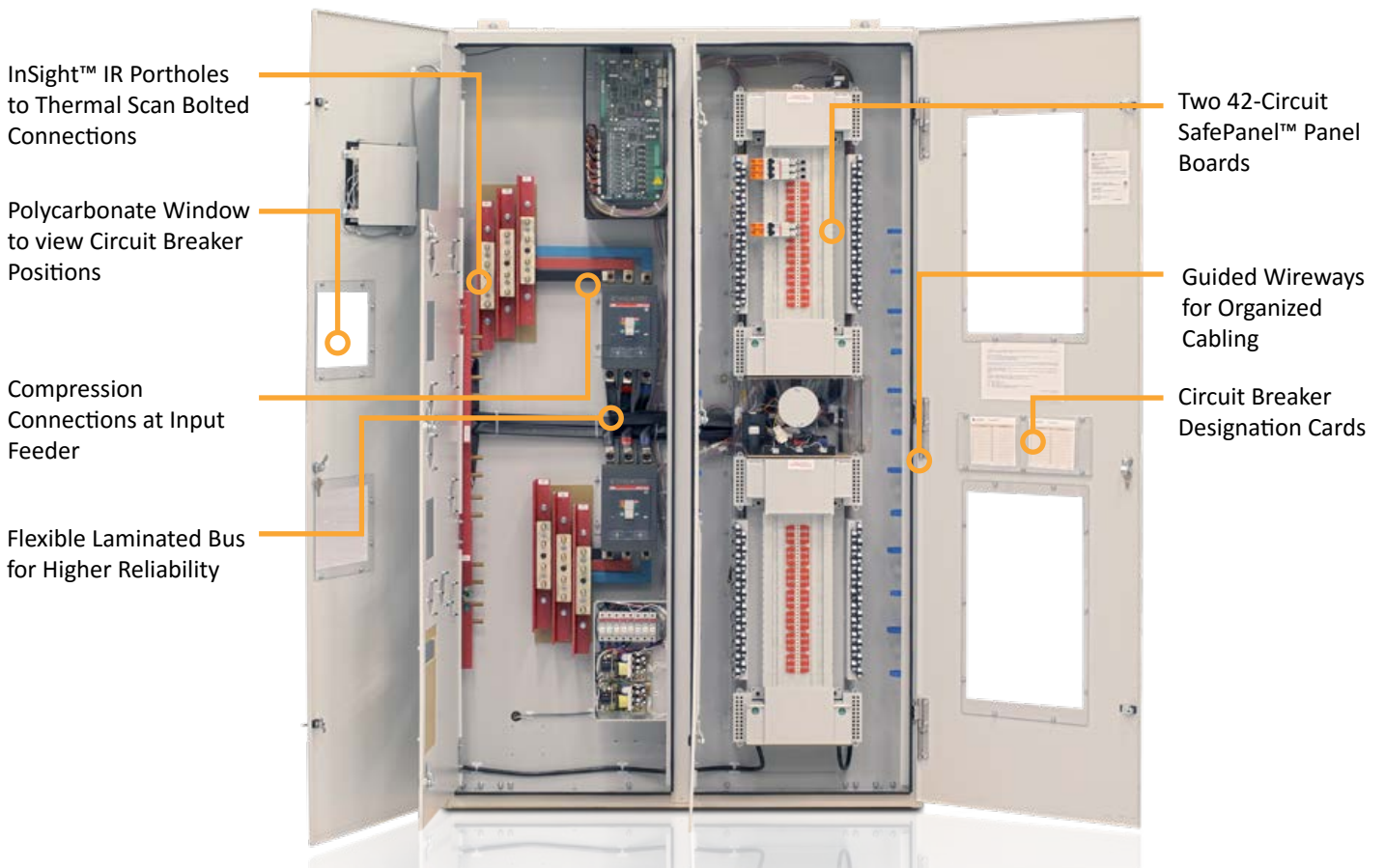

Reliability Features

Serialized circuit boards

We serialize and track all critical circuit boards and memory cards through our eBOSS portal, which allows customers to reference which components their machines are made from, who tested the components, as well as the ability to view notes generated from testing.

Serialized components offer the ability to drill-down on prospective component failure utilizing predictive modeling techniques, so if part fails, the instance can be cross-referenced with similar parts. This preventative maintenance helps ensure maximum uptime.



Sectionalized Components Help Maximize Operator Safety

Operators are well-protected from exposed connections. There is a physical separation between the main circuit breaker(s) and branch circuit breakers. All connections are optically isolated to minimize risk. Polycarbonate windows are utilized to permit visibility and maximize operator safety.

Energized parts are all insulated, covered, recessed, &/or internally mounted for safer operation of the unit. In addition, sections that isolate machine components are insulated.



Reliability Features

Selective Trip Coordination

LayerZero Series 70 ePanel-2 Wall-Mounted Power Panels are selective trip coordinated.

Selective Trip Coordination ensures that the main breaker will remain unaffected by the branch circuit breakers in the event of a downstream fault.

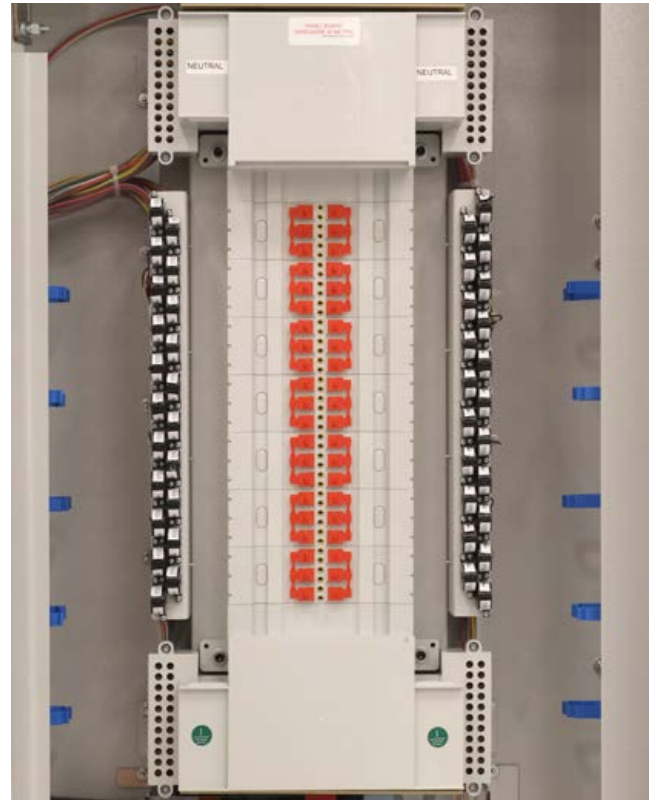

The Fault Current Opens the Solenoid Magnet, Causing The Contacts To Part



Unequal Pressure on Each Side of The Arc Causes the Plasma Wave To Rotate Away From The Contacts



The Plasma Wave is Driven into 12 Evenly Spaced Dividers



The Plasma is Rapidly Cooled



Transient Voltage Attempts To Re-Strike The Arc, But The Plasma Is Again Pushed Into The Dividers



When Sufficiently Cool, Charged Particles Recombine And The Fault Current Is Stopped Quickly & Safely

Ease of Maintenance/Safety Features

Scan Bolted Connections with Dead-Front Doors Closed

The left inner dead-front doors contain strategically positioned IR-scan portholes to enable safe thermal scanning of all bolted connections with the deadfront closed, without exposing the operator to power circuit voltage.

The IR window swivels upward and unlocks with key-hole access to reveal a mesh, allowing the operator to point-and-shoot thermal cameras to obtain accurate readings. LayerZero provides documentation for proper thermal scanning procedures.

**Polycarbonate Windows**

The Series 70: ePanel-2 is equipped with polycarbonate windows located on the outer doors. Circuit breaker positions can be viewed with the dead-front doors closed.

In addition, a hinged polycarbonate window on the input terminals increases safety by eliminating exposure to live bus.

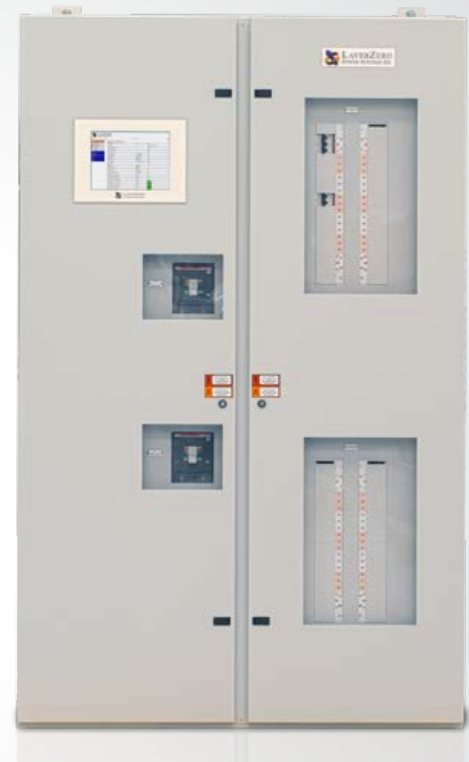

Safety Features

Circuit Breaker Shrouds

LayerZero Series 70 ePanel-2 Power Panel provides optional circuit breaker shrouds, designed to eliminate exposure to live parts.



No Exposed Live Parts

LayerZero's patent-pending Circuit Breaker Shrouds cover exposed wiring, maximizing operator safety.

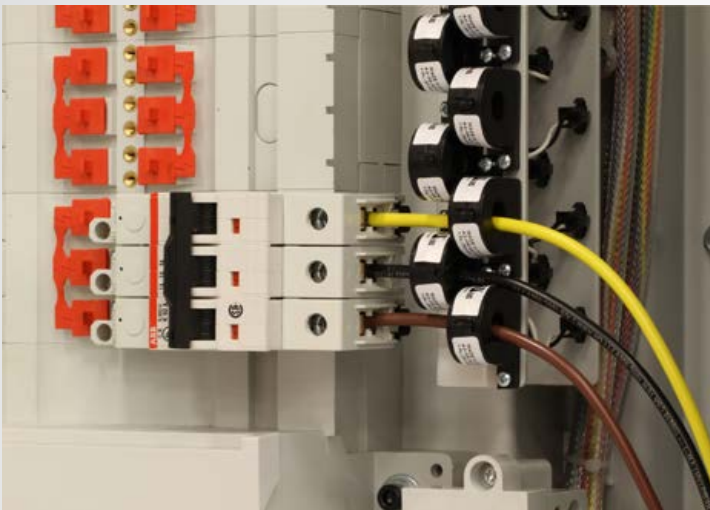

Wiring Without Shrouds Leaves Wiring Exposed

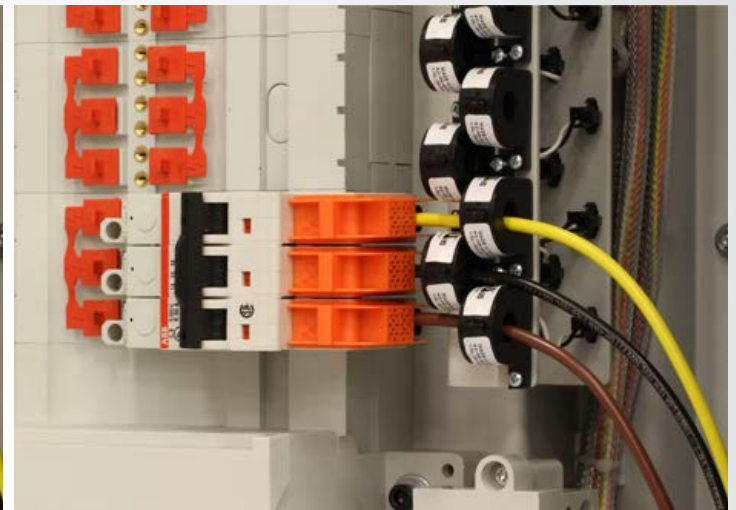

Circuit Breaker Shrouds Maximize Operator Safety

Safety Features

The LayerZero Finger-Safe SafePanel™

The Series 70 eRPP features an IP-20, finger-safe panel board, meaning that the opening will not allow ingress of ½” (12.5mm) diameter probe, for maximum operator safety.

An arc can form as two live conductors are separated – such as the removal of a circuit breaker from a panel board. The SafePanel design ensures that a potential arc would be contained in the connection well so that even if a branch breaker were to be removed, the arc would be contained in the connection well.

Insulated with the components deeply isolated, removal of the breaker is safe and easy.



Isolated, Non-Conducting Brass Screws



The Protective Cover Is Removed



The Breaker Is Inserted Into The Opening



The Breaker Snaps Into The DIN Rail



The Breaker Is Secured With An Isolated, Non Conducting Screw

Connectivity Options

Bluetooth Keeps Circuit Level Information Up-To-Date

Coordinate efforts to keep panel board naming conventions accurate and up-to-date with Bluetooth connectivity. In critical facilities, Facilities typically install the physical circuit breakers, while IT workers manage naming of panel designations.

With Bluetooth connectivity, the naming, size, and assignment of circuit breakers can be taken care of at the point-of-impact, bringing together the efforts of facilities and IT for more accurate deployment.

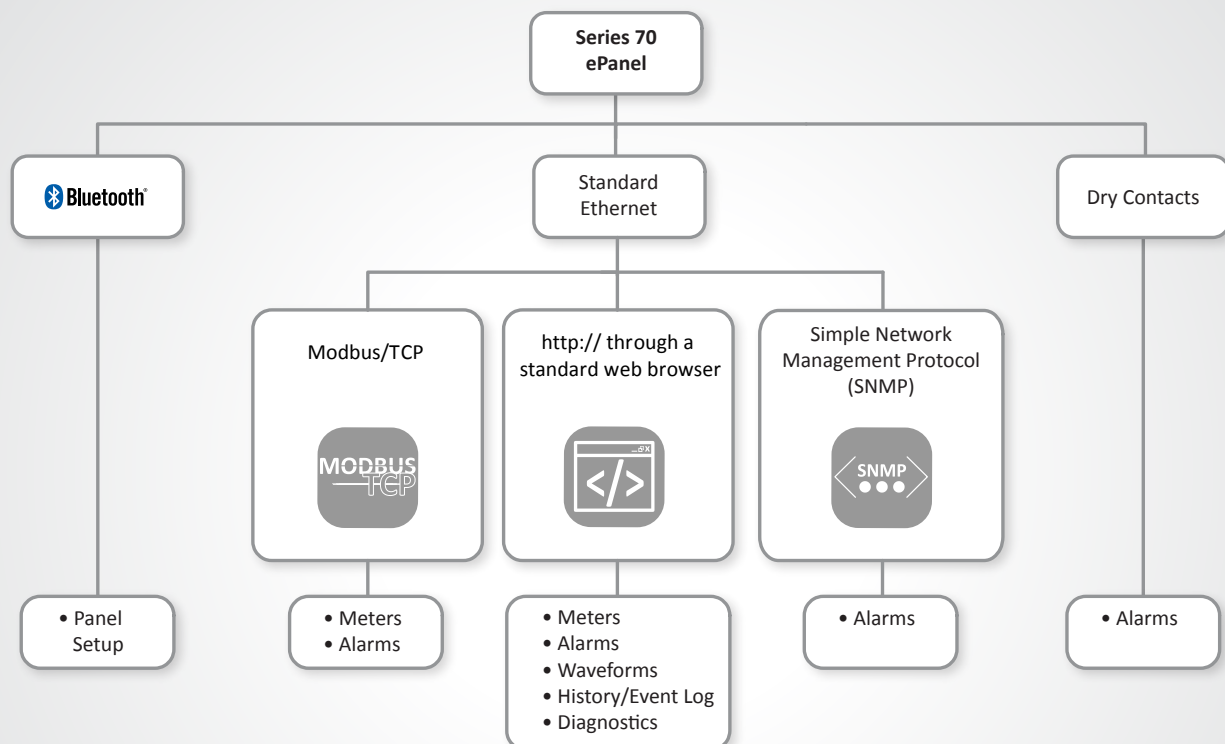

Power Quality Monitoring

zen DPQM

The Series 70 ePanel-2 is equipped with Zen DPQM (Distribution Power Quality Monitoring), an all encompassing monitoring system with local and remote communications options.

From basic monitoring & alarm reporting, to advanced power quality monitoring functionality, Zen DPQM provides a wide-range of options to help you be aware, be vigilant, be proactive in your quest to create a safe, stable and reliable operation.



Zen DPQM Provides Answers

Zen DPQM provides timestamped pictures of waveforms before and after events, providing information that enables facilities to go back in time to methodically identify and correct the root causes of events. Zen actively captures power quality information at the STS, PDU, and RPP - permitting thorough post-event analysis.

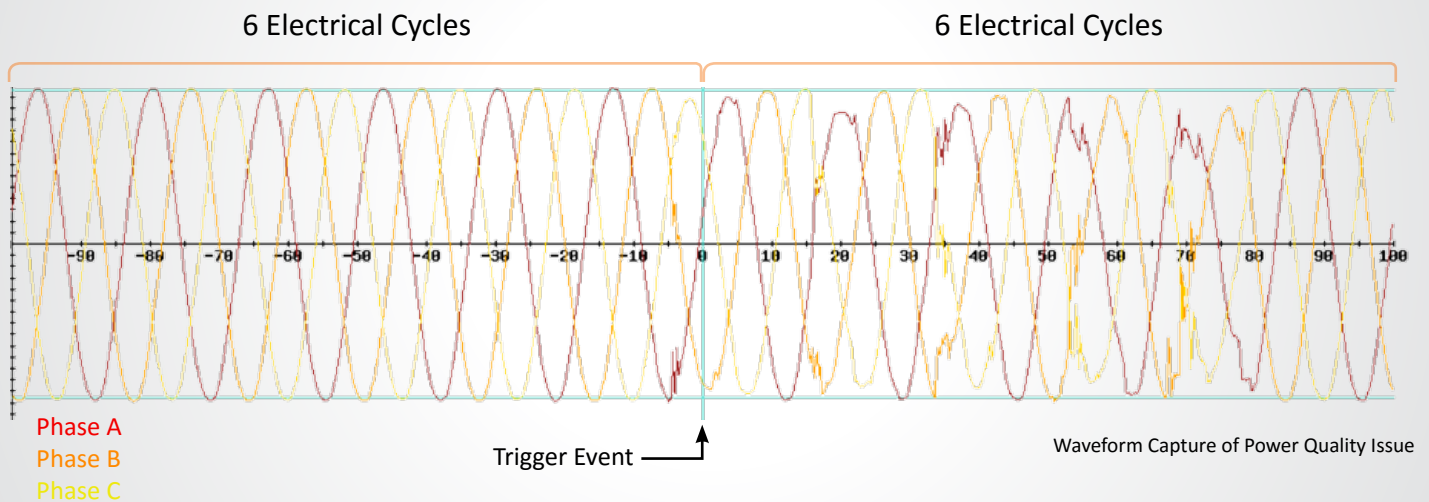

zen DPQM

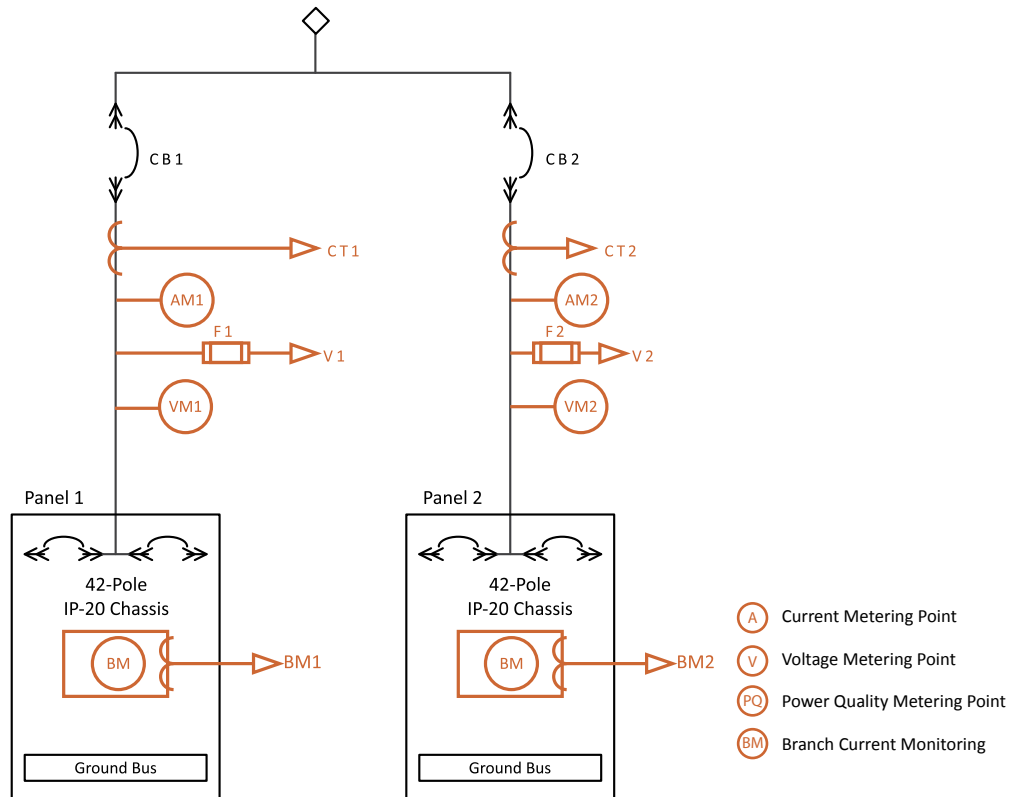
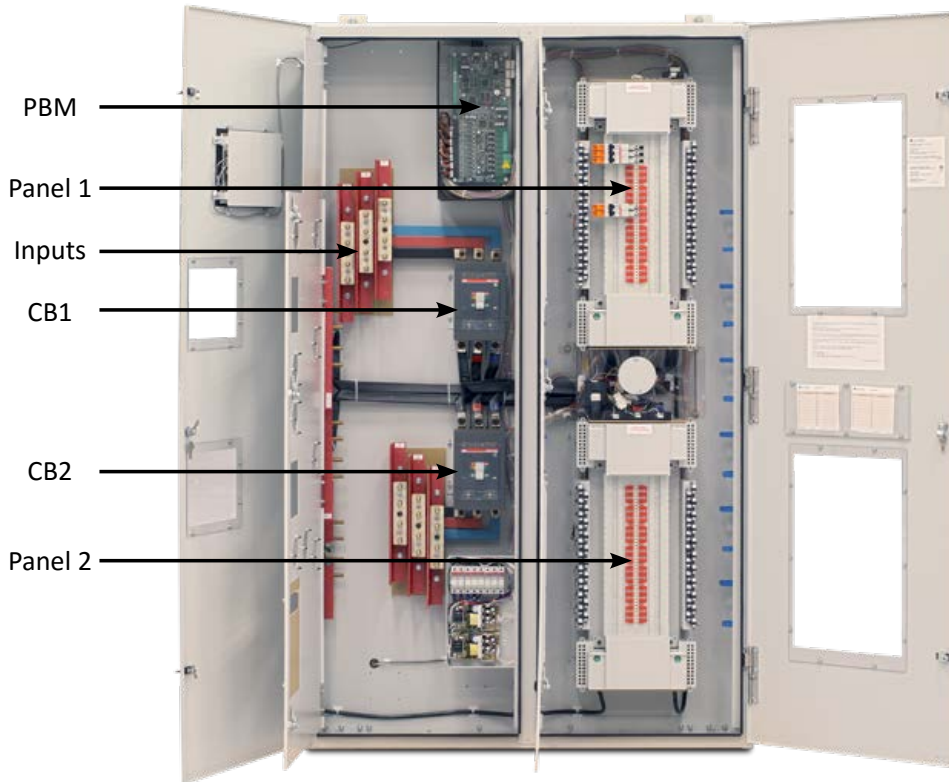

Technical Specifications

Zen DPQM Parameters		Mains	Subfeeds or Branch Circuits
Voltage Monitor	Volts (L-L) Phase A/B/C (volts RMS)	✓	
	Volts (L-N) Phase A/B/C (volts RMS)	✓	
	Phase Rotation	✓	
Current Monitor	CT Reversed Phase A/B/C/N	✓	✓
	Current Phase A/B/C/N (amperes RMS)	✓	✓
Power Monitor	Frequency (hertz)	✓	
	Real Power (kilowatts)	✓	✓
	Apparent Power (kilovolt-amperes)	✓	✓
	Reactive Power (kilovolt-amperes reactive)	✓	✓
	Power Factor	✓	✓
	Energy (kilowatt-hours)	✓	✓
	Block Demand (kilowatts)	✓	✓
	Block Demand Peak (kilowatts)	✓	✓
	Rolling Demand (kilowatts)	✓	✓
	Rolling Demand Peak (kilowatts)	✓	✓
Power Quality	Percent VTHD (percent)	✓	✓
	Waveform Capture	✓	✓
Alarms	Phase - Under Voltage A/B/C (Alarm)	✓	
	Phase - Over Voltage A/B/C (Alarm)	✓	
	Phase - Low Voltage A/B/C (Warning)	✓	
	Phase - High Voltage A/B/C (Warning)	✓	
	Phase - Over Current A/B/C (Alarm)	✓	✓
	Phase - High Current A/B/C (Warning)	✓	✓
	Under Frequency (Alarm)	✓	
	Over Frequency (Alarm)	✓	
	High VTHD (Warning)	✓	
	Over VTHD (Alarm)	✓	
	Phase Rotation (Alarm)	✓	

All product specifications are subject to change without notice.

Technical Specifications

ePanel-2 Models with System Withstand Ratings	
	Presence of Main Circuit Breaker
120/208 V, 3-Phase, 4-Wire + Ground	35 kA
220/380 V, 3-Phase, 4-Wire + Ground	14 kA
230/400 V, 3-Phase, 4-Wire + Ground	
240/415 V, 3-Phase, 4-Wire + Ground	
277/480 V, 3-Phase, 4-Wire + Ground	
480 V, 3-Phase, 3-Wire + Ground	

Mechanical Characteristics	
Dimensions	47"W x 80"H x 10.5"D (1193 mm W x 2032 mm H x 266.7 mm)
Weight	550 lbs (250 kg)
Enclosure Mounting	Wall-Mounted
Frame Construction	Welded Frame
Electrical Connections	Flexible Laminated Bus, Silver-Plated Solid Busbar
Color	Textured Powder Coat White (RAL 7035), Blue (RAL 5017), Black, Custom
Seismic Floor Anchors	Optional
Seismic Floor Stand	Optional
Sectionalization	Engineered Composite Insulation, Dead Front Doors
Circuit Breaker Identification	Labels Viewable Through Polycarbonate Window

Electrical Characteristics	
Input Voltage	120/208 V, 3-Phase, 4-Wire + Ground; 220/380 V, 3-Phase, 4-Wire + Ground; 230/400 V, 3-Phase, 4-Wire + Ground; 240/415 V, 3-Phase, 4-Wire + Ground; 277/480 V, 3-Phase, 4-Wire + Ground; 480 V, 3-Phase, 3-Wire + Ground
Configuration	1 Input, 2 Panels
	Parallel (P), Shared Parallel (SP)
Configuration	2 Inputs, 2 Panels
	Dedicated (D), Feed Through (FT)
Frequency	50 Hz, 60 Hz
Poles	3-pole, 4-pole
Input Feeder Termination	Single, Mechanical; Dual, Mechanical; Two-Hole, Compression
Phases	3-Phase, 3-Wire (Input); 3-Phase, 4-Wire + Ground (Output)
Neutral Rating	100%, 200%
Circuit Breaker Mounting Type	Fixed, Plug-In
Distribution	SafePanel™ Distribution
Number of Output CBs	84-Circuit

Power Quality Monitoring	
Power Quality Monitoring Technology	Zen DPQM™ (Distribution Power Quality Monitoring)
Waveform Capture	Local Display, Remote Display via Web Browser

All product specifications are subject to change without notice.

Technical Specifications

Operational Characteristics	
Cooling	Convection Cooling
Cable Access	Top/Bottom
Service Access	Front Only Access
IR Scan Port Type	InSight™ IR Portholes
Display Type	3.2" LCD with Membrane, 10.5" Color Touch Screen GUI (Optional)
Connectivity	
Meters	Local Display, Ethernet, Modbus/TCP, http via Web Browser (Non-Proprietary)
Alarms	Local Display, Ethernet, Modbus/TCP, http via Web Browser (Non-Proprietary)
Summary Alarm	Dry Contacts
Waveforms	Local Display, Ethernet, http via Web Browser (Non-Proprietary)
History/Event Log	Local Display, Ethernet, http via Web Browser (Non-Proprietary)
Diagnostics	Local Display, Ethernet, http via Web Browser (Non-Proprietary)
Time Synchronization	Network Time Protocol (NTP)
Standards Conformance	
UL	ETL and cETL listed to UL 60950

Contact LayerZero for custom sizes and designs.

All product specifications are subject to change without notice.

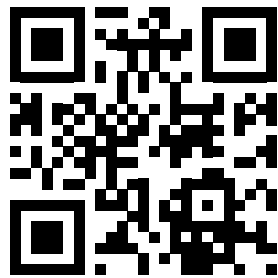

Learn more at www.LayerZero.com



LayerZero Power Systems, Inc.
1500 Danner Drive
Aurora, OH 44202 U.S.A.

© 2016 LayerZero Power Systems, Inc.

LayerZero Power Systems, LayerZero.com and the LayerZero logo are registered trademark of LayerZero.
All product specifications are subject to change without notice.

Rev. 8/16 #9